

FIRST TIME USE

1

Tank setup. Place the shuttle tank and buffer tanks on a completely level and firm table that can support the weight of the tanks with water in them.

Place the buffer tanks in close vicinity to the shuttle tank to keep tubing length at a minimum. Allow space for pumps, valves, tubing (avoid kinks), and fittings.

2

Recirculation loop setup. Use the schematic (Setup Guide I, Recirculation) to set up the recirculation loop. The pumps must be connected to grounded outlets and run continuously (2, R1 + R2).

3

Increasing and decreasing loop setup. Use the schematic (Setup Guide I, Increasing + Decreasing) to set up the increasing and decreasing loop. The valves for the increasing (2, V1 + V3) and decreasing loop (2, V2 + V4) connect to the PowerX4.

Connect each valve to its designated gas source, and place the air stones at the bottom of the buffer tanks (Setup Guide I). The gas sources (not included) should have sufficient capacity to support your experiments. Instead of using O₂ supplied in a compressed gas bottle, the oxygen concentration can be controlled using compressed laboratory air or an air pump. The response of the system will depend on the air supply. If a longer diffusion pathway is desired, when bubbling with O₂ or N₂, lower the buffer tanks compared to the shuttle tank to obtain a higher water column.

The buffer tank comes with six fittings for tube connections. Only two ○ are used for the Shuttle box system for oxygen. Close off the remaining ● with a short piece of tubing (Setup Guide I).

4

Sensor placement. Place the oxygen probes (CellOx 325) directly inside the buffer tanks away from the air stones, and make sure that the tip of the probe is covered by the water flowing to the tanks (Setup Guide II, Sensors).

5

Camera placement. The camera must be centered and positioned sufficiently high above the shuttle tank to obtain a field of view that covers the entire area in which the animal can move around in (Setup Guide II, Camera). If using multiple tanks, use one camera per tank.

IMPORTANT. Once the camera has been positioned correctly, it must not be moved as you will then have to perform a new pixel-calibration.

6

Lighting conditions. We recommend using backlighting of the shuttle tank (such as an IR light panel placed underneath the tank) to improve the contrast between the animal and background (6). Overhead lighting can cause water surface reflections, and may also affect animal behavior.

Make sure to have spacing between the IR light panel and the shuttle tank to avoid unwanted temperature effects as IR light panels can run hot during operation (Setup Guide II, Camera).

7

Adjusting flow rate. Check that the direction of flow is correct (Setup Guide I, Recirculation). For optimum separation of flows, it is important to that both sub-compartments in the shuttle tank are fed with exactly equal flow rates. We recommend water velocities of max 5 cm/sec in the shuttle tank.

To adjust the flow rate (Setup Guide II, Adjust flow):

1. Raise or lower the position of the buffer tanks relative to the shuttle tank.
2. Use tube clamps  on the tubing going from each recirculation pump to the buffer tanks.

8

Avoid mixing. To avoid mixing between the two sub-compartments, it is important that the water surface level is equal between the two sides, i.e., to avoid water from one side entering the other due to pressure differences (gravity). The separation of flow between the two subcompartments can be visualized by adding a colored dye (e.g., red wine or food coloring) to one sub-compartment and follow it over time (8).

9

Next step. Now refer to the [Quick guide - ShuttleSoft v3](#) on how to set up instruments in ShuttleSoft v3 and how to use the software with the shuttle box system.

2

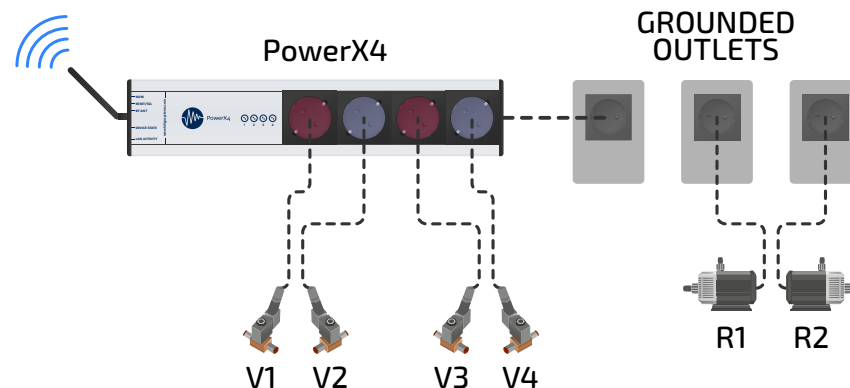

6

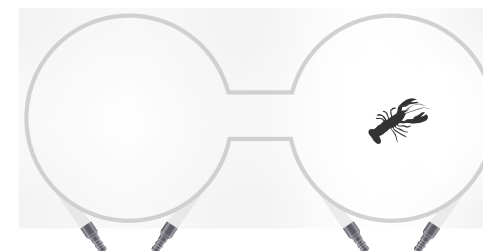
WITHOUT
IR BACKGROUND LIGHTINGWITH
IR BACKGROUND LIGHTING

8

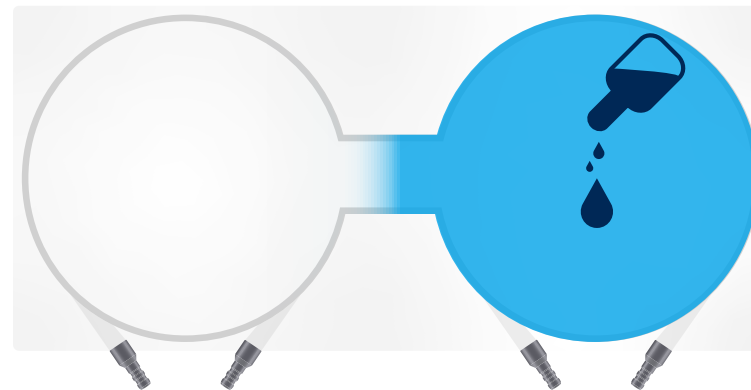

CALIBRATION, CLEANING, AND MAINTENANCE

pH -> CO₂ conversion: Calibrate (12) the WTW SenTix HWD pH probe before conversion. Prepare three water samples of the same quality (i.e. buffer capacity) as the water used for experiments, and keep water temperature constant and the same.

Use a gas mixing pump (Wösthof), mass flow cells, or ready-made gas mix to bubble the three samples at three different pCO₂ levels within the range of your experiment min/max pCO₂ level.

Place the SenTix HWD pH probe in the first water sample, click the to measure pH, and then type in the corresponding pCO₂ level. Click to add the next measurement point (10). Perform three measurements per water sample to ensure stabilized readings. The conversion is now done.

When to calibrate... In general, you should perform a new sensor calibration if you experience sensor performance issues (e.g. signal drift). Otherwise, a new calibration is recommended:

- **WTW Oxi 3310 (CellOx 325):** When the probe symbol flashes (after the set calibration interval has expired (150 days as standard)) or when using a new probe.
- **WTW Cond 3310 (TetraCon 325):** Every 6 months or when using a new probe.
- **WTW pH 3310 (SenTix HWD):** When the probe symbol flashes (after the set calibration interval has expired (7 days as standard)) or when using a new probe.
- **Witrox:** When the % air sat. level drifts with > +/-2 % or when using a new oxygen sensor. The temp. probe is pre-calibrated and cannot be manually calibrated.

Calibrate a WTW probe: Please see the respective WTW meter user manual for more instructions. Each manual can be found at: loligosystems.com/manuals

Calibrate a Witrox oxygen sensor: In ShuttleSoft v3 > Main menu > Calibration > Choose Witrox instrument. Click on the relevant channel (CH1-CH4) to open the channel calibration menu (13). Select the type of temperature input (Witrox controlled or User defined) and then perform a **Manual 2-point calibration** (13 and 13.1):

- Place the sensor tip in a mixed air-equilibrated water sample. This can be achieved by purging atmospheric air into sample water, e.g. with an air pump.
- Wait for the phase reading (sensor signal) to stabilize and then click **Read current values** to save the current value as the HIGH calibration value (100 % air saturation).
- Transfer the sensor to an oxygen free water sample, e.g. by purging nitrogen gas into sample water or by dissolving ~10 grams of Na₂SO₃ in 500 ml of distilled water.
- Wait for the phase reading to stabilize and then click **Read current values** to save the current sensor signals as the LOW calibration value (0 % air saturation).

How to clean... In general, clean each instrument and sensor between uses.

- **WTW probes:** Please follow the cleaning instructions provided in the manual for the CellOx 325, TetraCon 325, or SenTix HWD probe. Each manual can be found at: loligosystems.com/manuals
- **Witrox oxygen sensor:** Use a mild soap solution or bleach, and rinse with demi water. Then dry (14).
- **WTW and Witrox meters:** Wipe the outside of the measuring instrument with a damp, lint-free cloth. Disinfect the housing with isopropanol as required. Avoid contact with acetone or similar detergents that contain solvents.

How to store... Store all sensors in a dark, dry place between trials. Avoid exposing the fluorescent dye on the Witrox oxygen sensor to UV light. UV light will bleach the sensor dye and decrease the signal strength (amplitude).

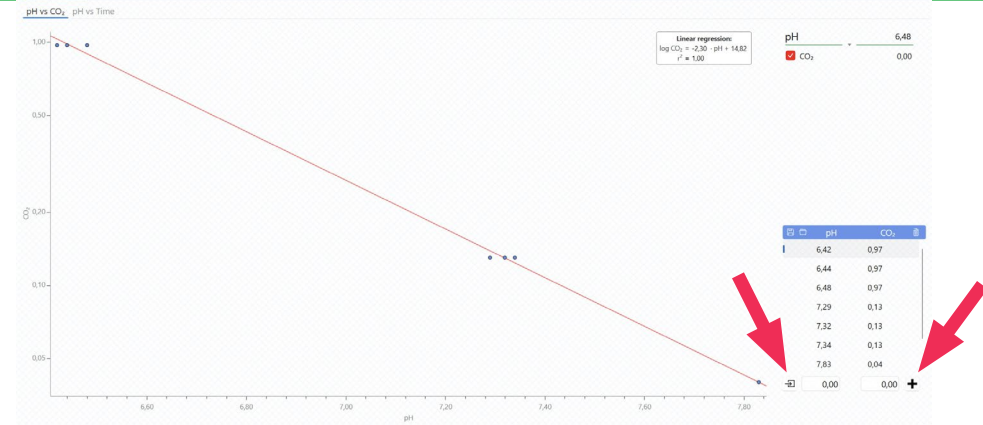

13

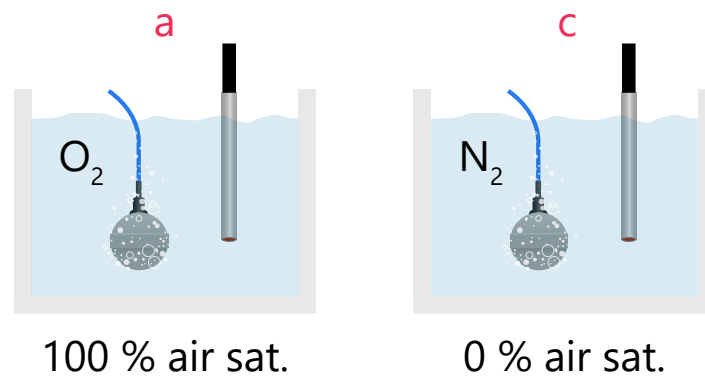

Channel 1

Settings

Moving average: None

2-point calibration

Input: Witrox

Temperature [°C]

| | Phase [°] | Temp. [°] |
|-----------------------|-----------|-----------|
| Low (0 % air sat.) | 58,00 | 20,00 |
| High (100 % air sat.) | 28,00 | 20,00 |

OK Cancel

13.1

Phase [°] Temp. [°]

| | |
|-------|-------|
| 58,00 | 20,00 |
| 30,37 | 20,00 |

Read and use phase and temperature value

Phase [°] Temp. [°]

| | |
|-------|-------|
| 53,79 | 20,00 |
|-------|-------|

Read and use phase and temperature value

14

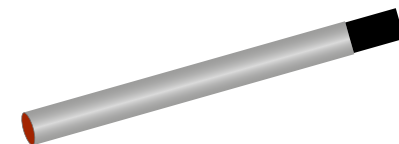
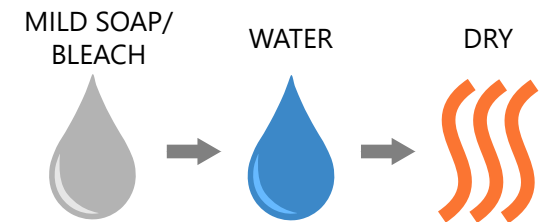

10

11

12

13

14

15

Shuttle Box System Oxygen

- = PVC tubing (recirculation)
- = PU tubing (decreasing)
- = PU tubing (increasing)
- - - - = Power cable
- = Bluetooth connection to PC

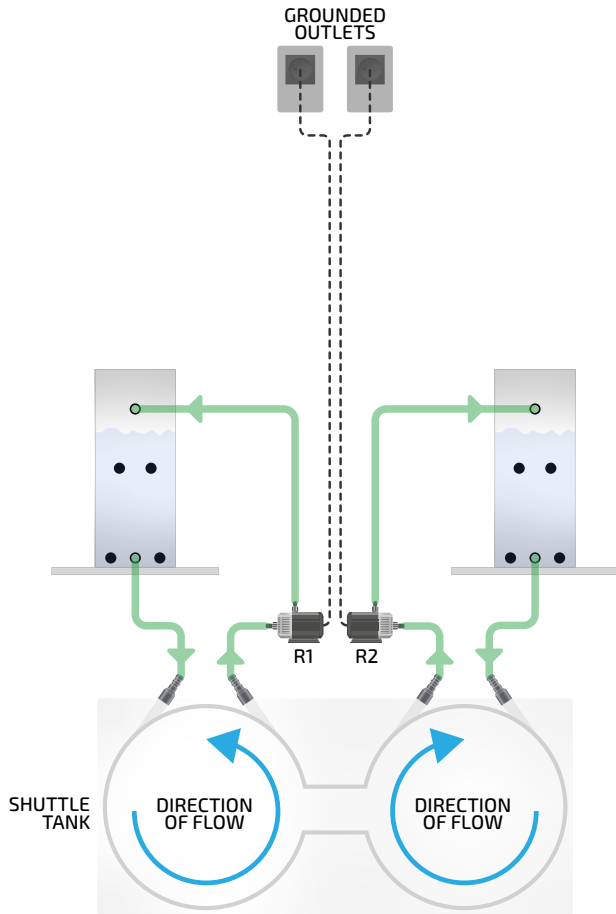

RECIRCULATION

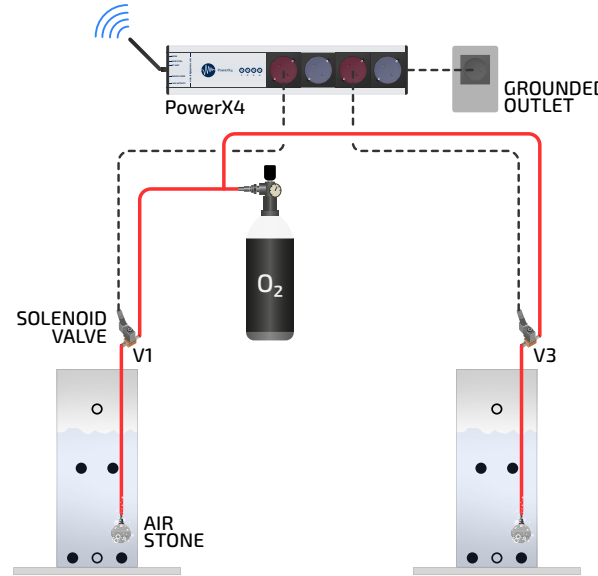

INCREASING

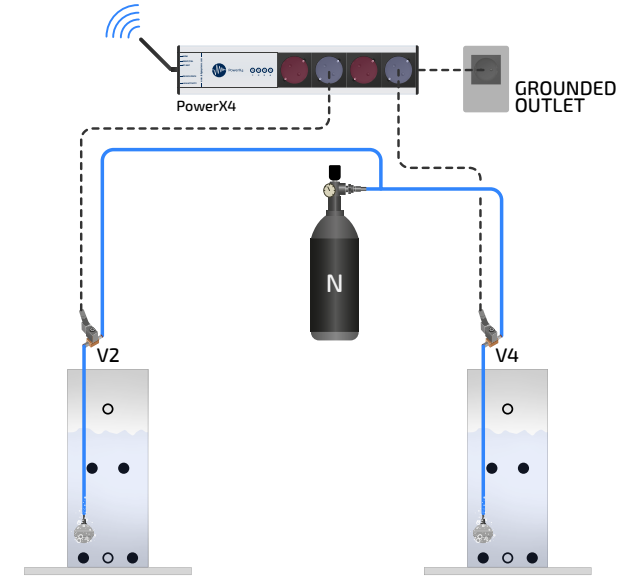

DECREASING

Shuttle Box System Oxygen

- = USB C (3.1) cable
- = USB B cable
- = Data cable
- = PVC tubing (recirculation)
- = Power cable

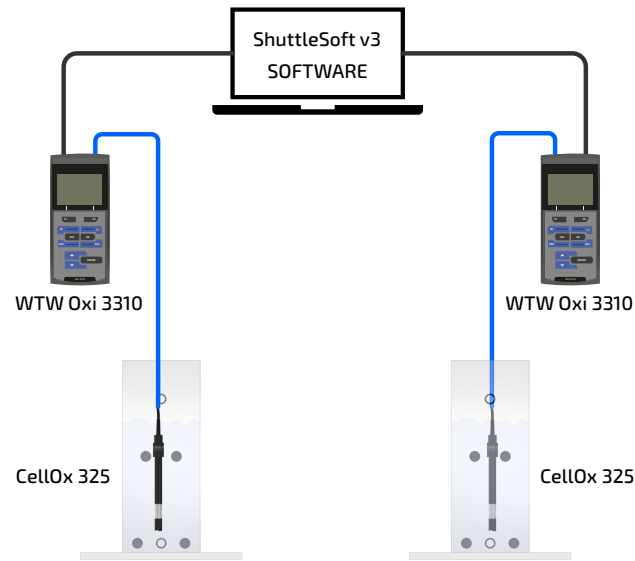

SENSORS

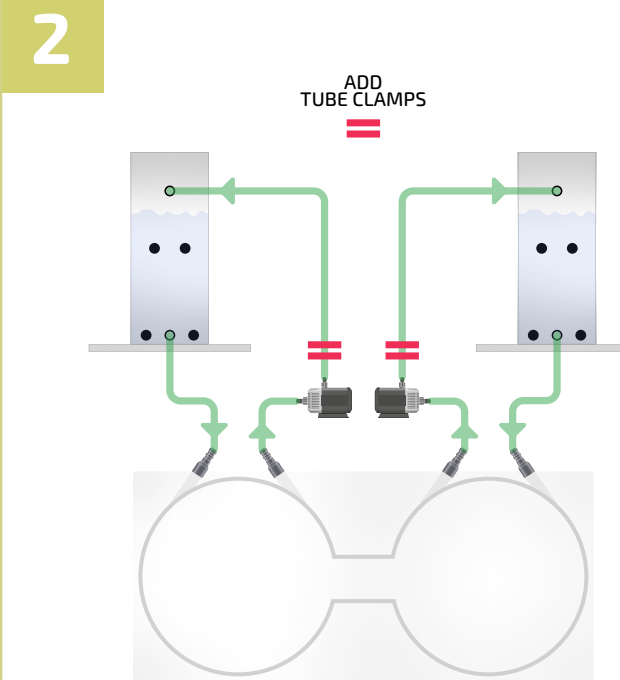
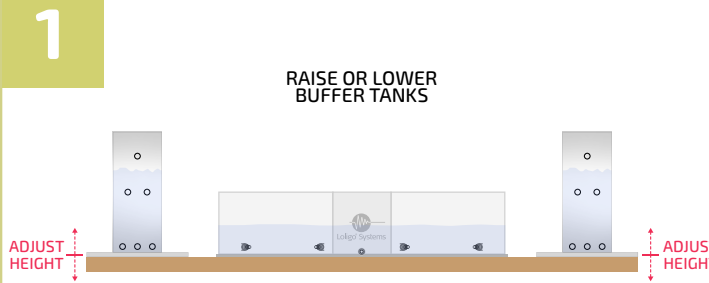

ADJUST FLOW

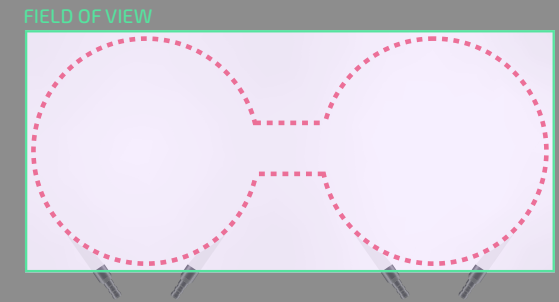
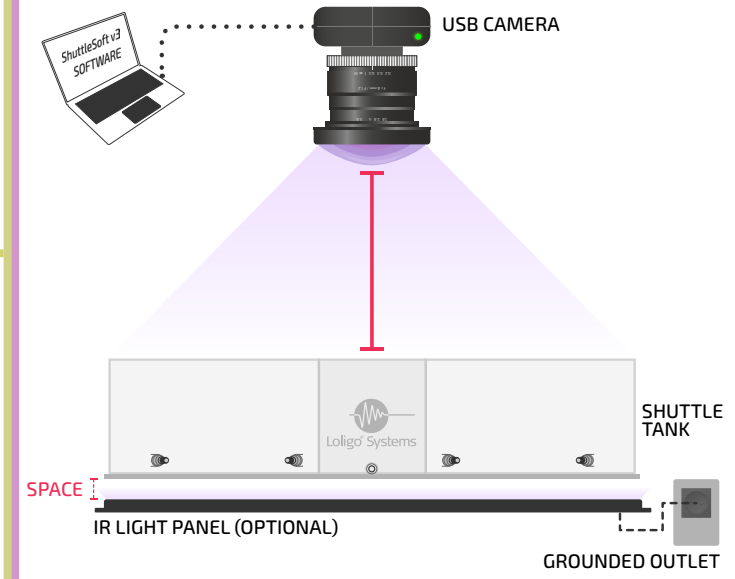

CAMERA